

SIRUBA®

銀箭牌工業用縫紉機
INDUSTRIAL SEWING MACHINE

L818F-RM1











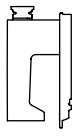

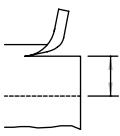
零件圖 PARTS LIST

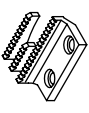

CE

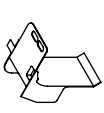

高林股份有限公司
KAULIN MFG. CO., LTD.

												
MODEL 機型	SUB-CLASS 規格	GAUGE WIDTH 切邊距離	NEEDLE PLATE 針板	FEED DOG 送具	PRESSER FOOT 押具	HOOK ASM 梭頭	BOBBIN CASE ASM 梭殼	BOBBIN 梭子	THROAT PLATE CHIP GUARD 下導布架	NEEDLE 針號	THREAD GUIDE 導線片	THROAT PLATE COVER 布板蓋
L818F-RM1-32	32	1/8" (3.2mm)	E705Q	D705	P705	G111	G201	G301	LR104DS	DB*1#14	LR141S	LR106
L818F-RM1-64	64	1/4" (6.4mm)	E705S E705Q	D702 D705	P701 P705	G111	G201	G301	LR104D LR104DS	DB*1#14	LR141 LR141S	LR106 LR106S
L818F-RM1-95	95	3/8" (9.5mm)	E705T E705Q	D702 D705	P701 P705	G111	G201	G301	LR104D LR104DS	DB*1#14	LR141 LR141S	LR106 LR106T

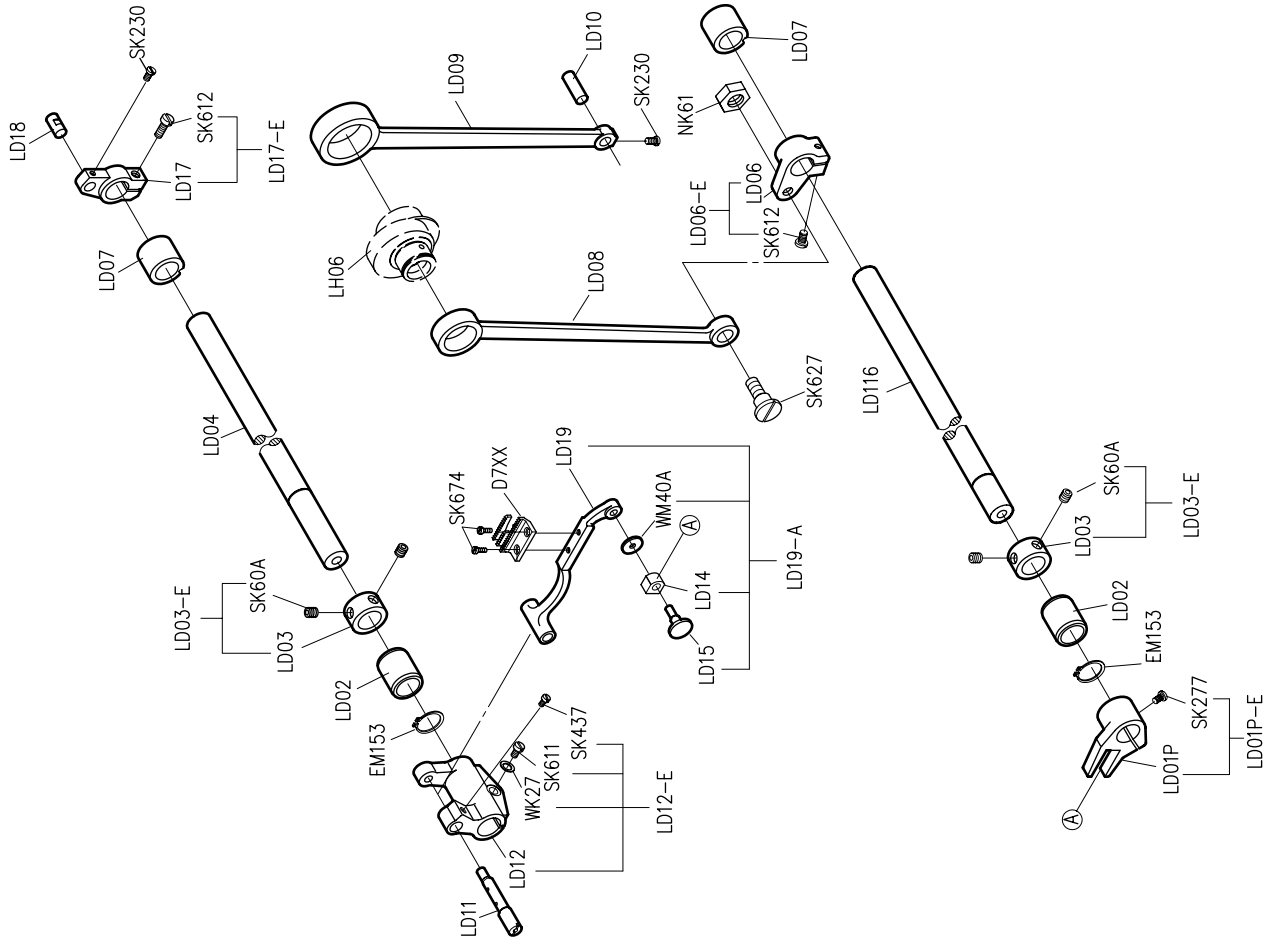

PARTS LIST FOR LD GROUP

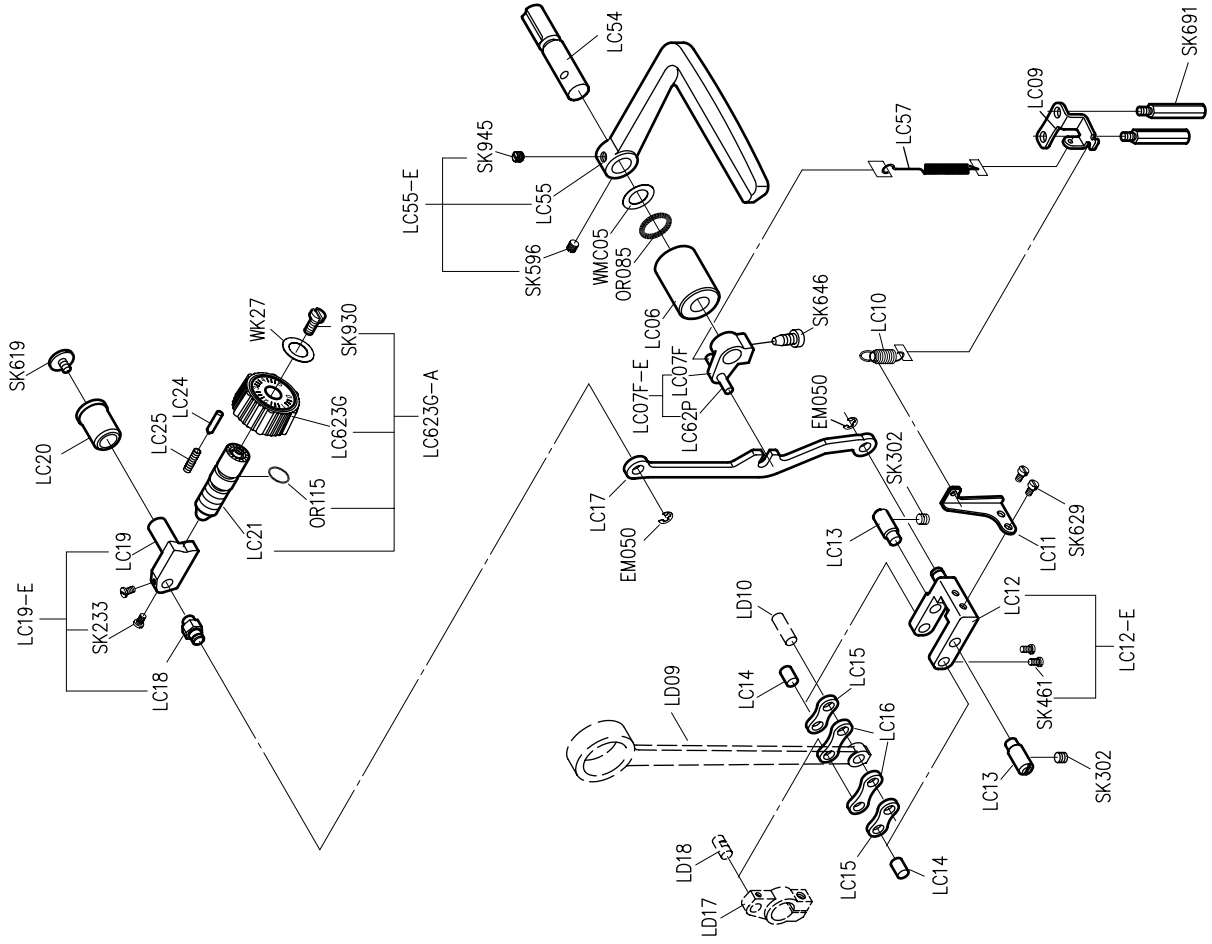

PARTS LIST FOR LC GROUP

PARTS LIST FOR LG GROUP

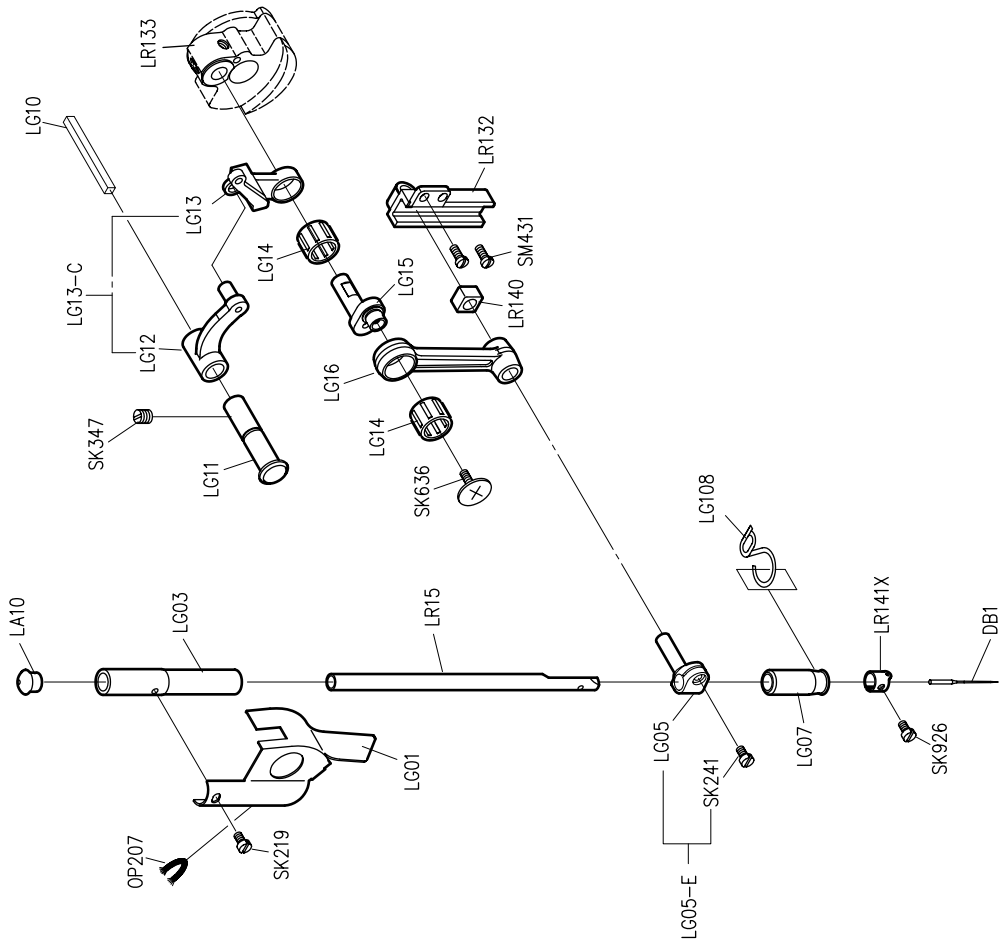

PARTS LIST FOR LE GROUP

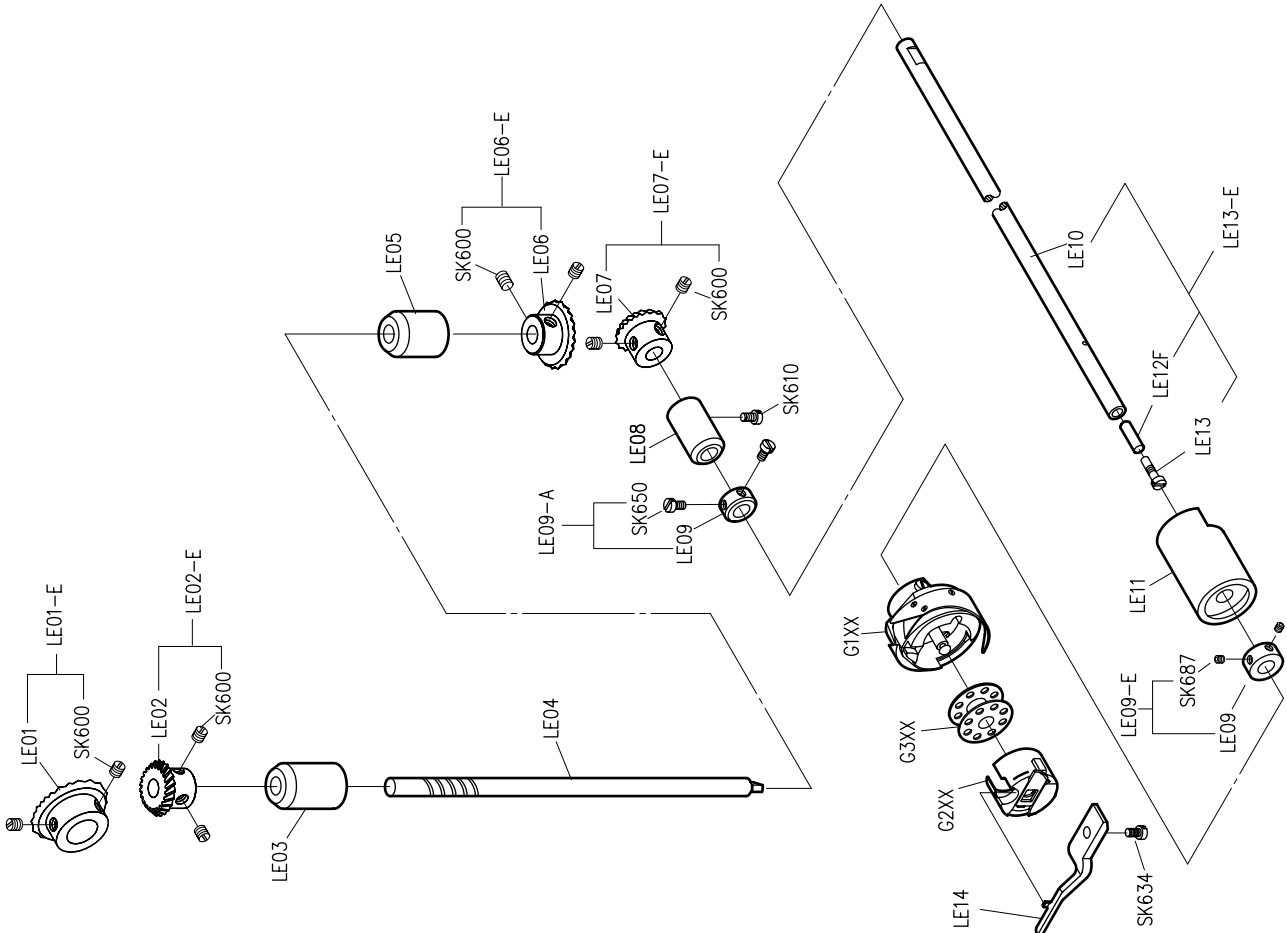

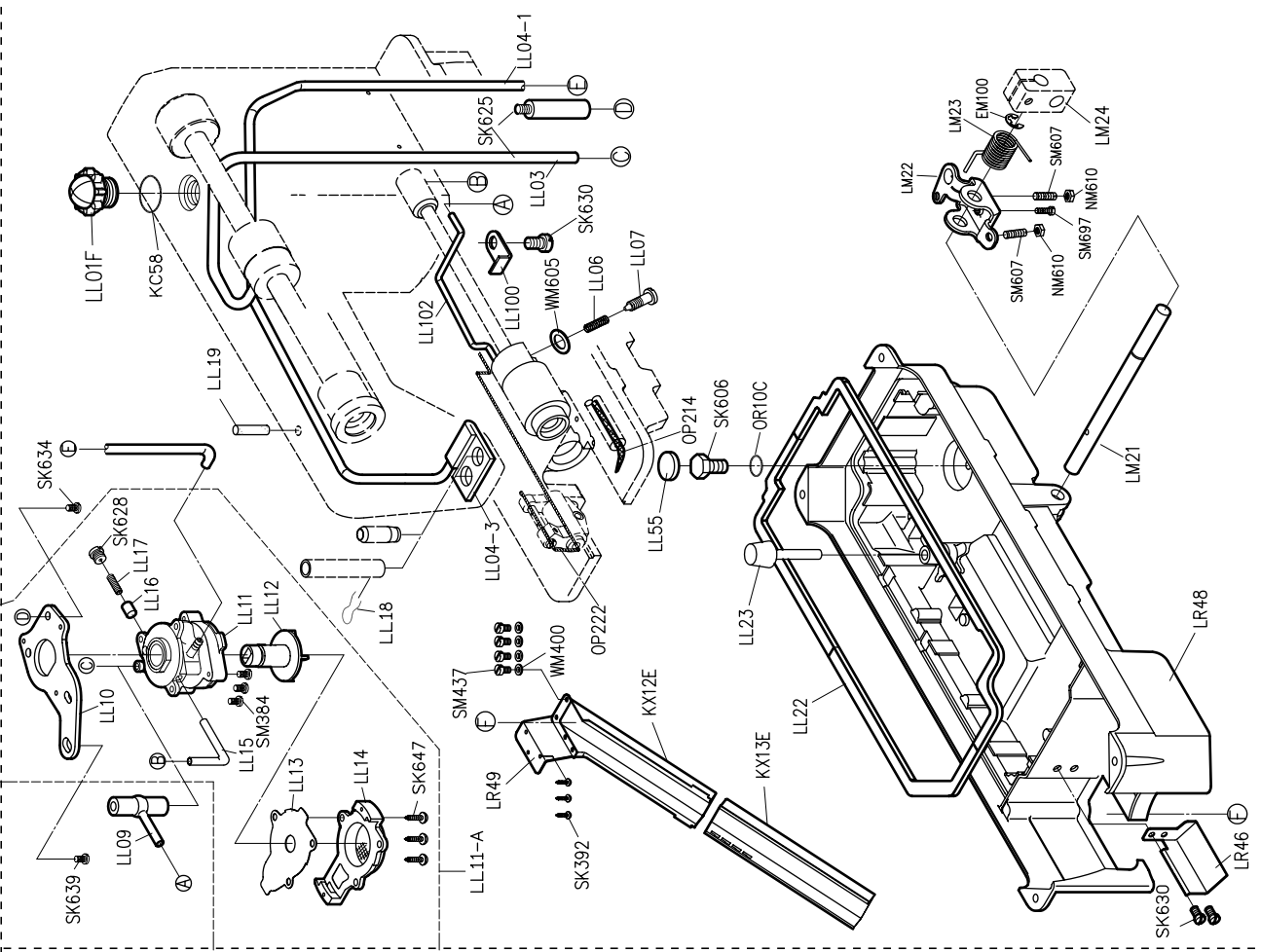

PARTS LIST FOR LL GROUP

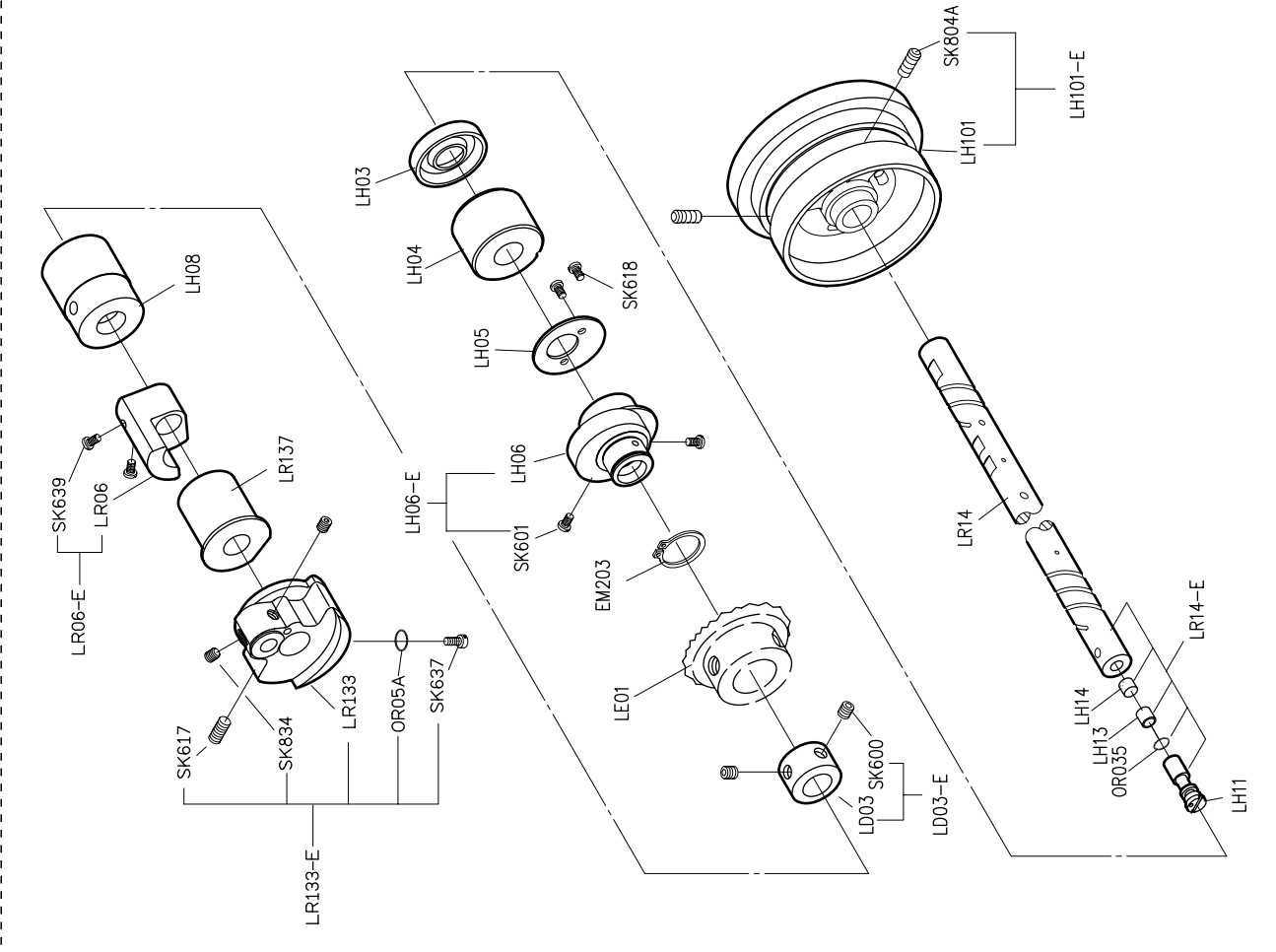

PARTS LIST FOR LH GROUP

PARTS LIST FOR LR GROUP

PARTS LIST FOR LM GROUP

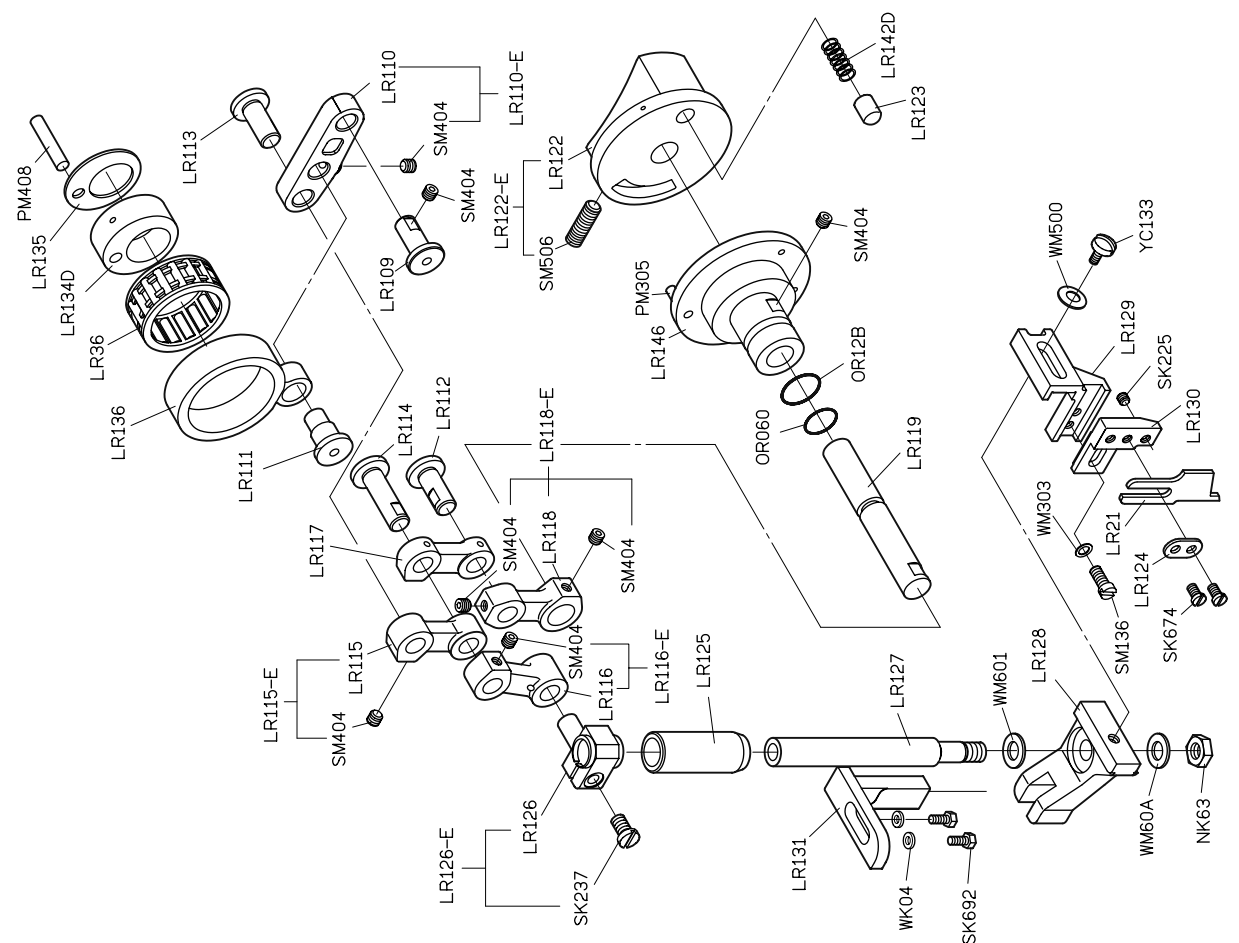
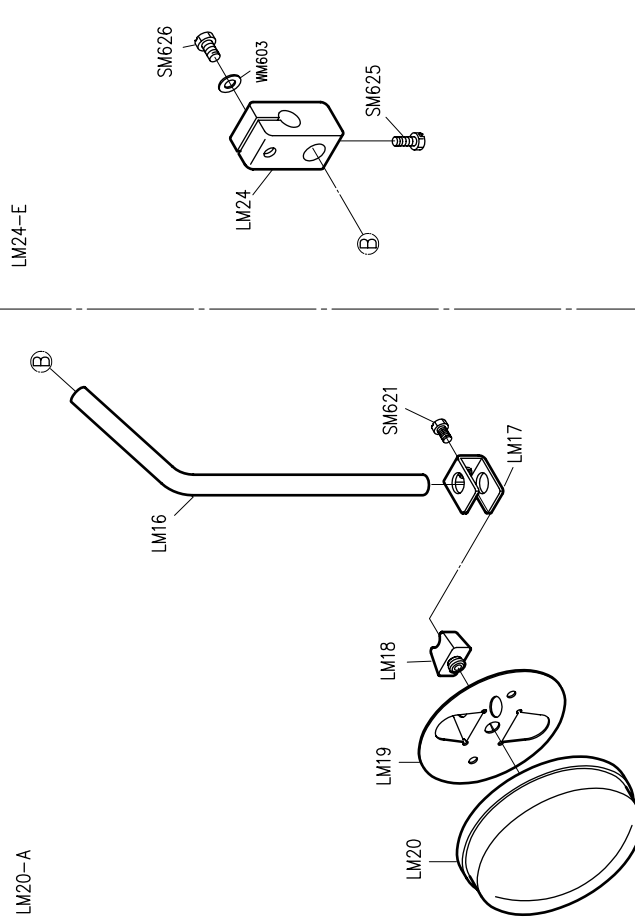
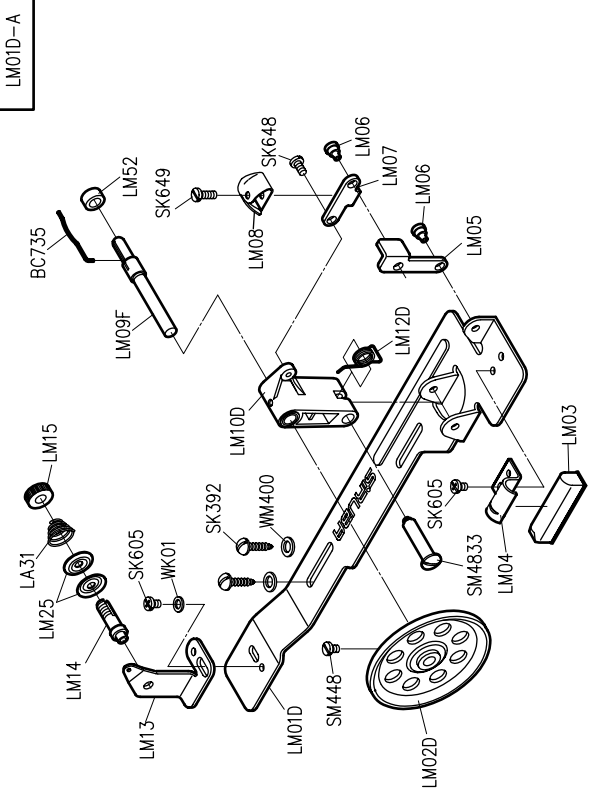

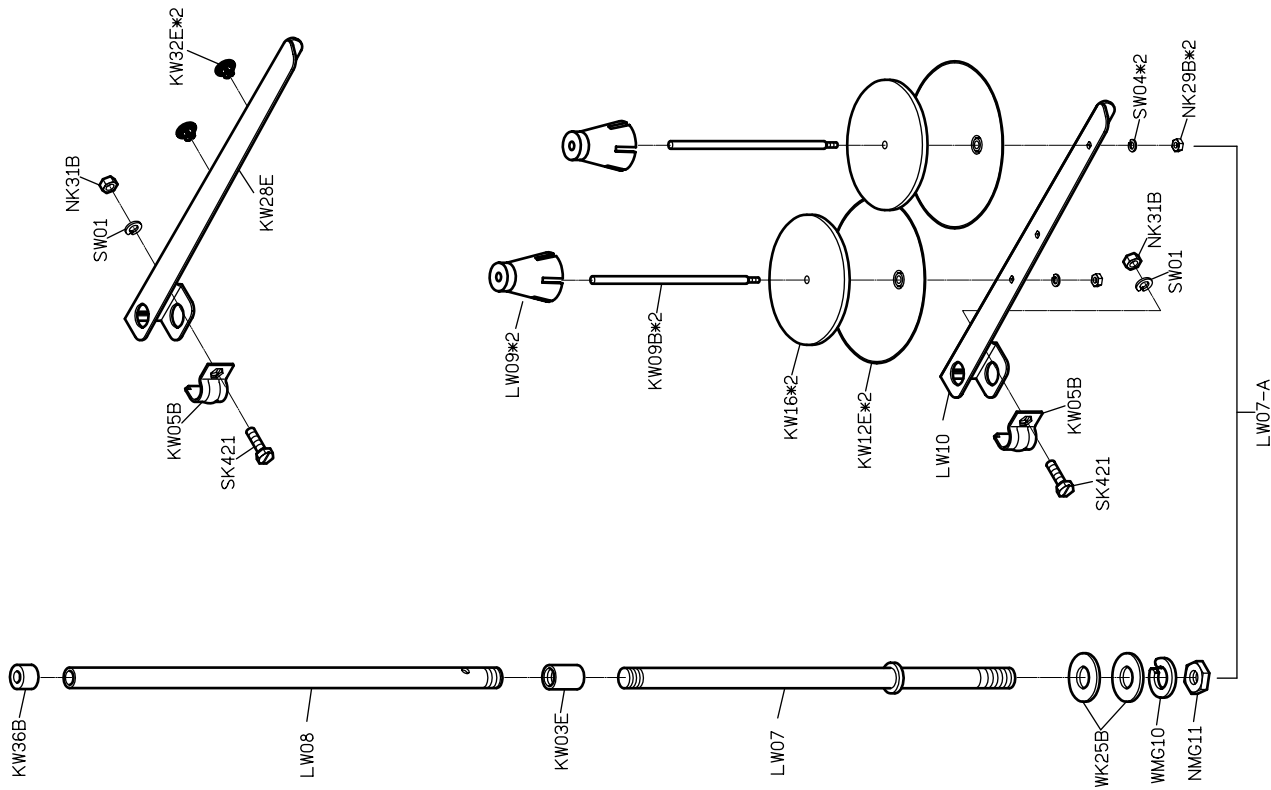

PARTS LIST FOR THREAD STAND GROUP

L Y01	L Y02	Y M04*2	L Y05*2	Y M102*2
L Y08F	L Y19	L Y24	L Y21-A	Y M103*2
#*2	MY01	MY01	MY11	KZ03*1
MY13	KY16	KY17	KY26F	

PARTS LIST FOR LY GROUP

PARTS LIST FOR LZ GROUP

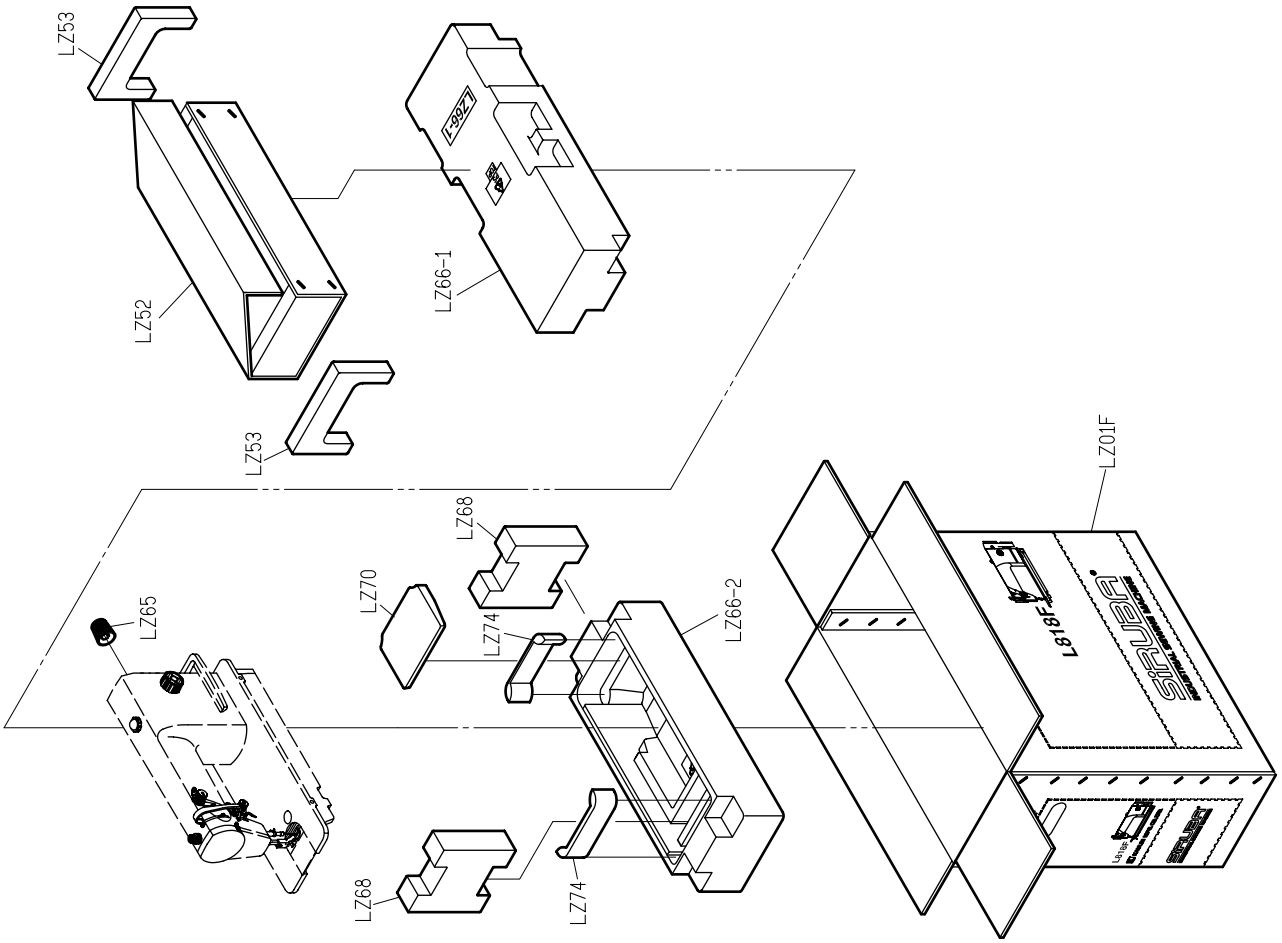



L818F-RM1

高林股份有限公司 KAULIN MFG. CO., LTD.